

# PRODUCTS CATALOG

Single Use Surgical Instruments

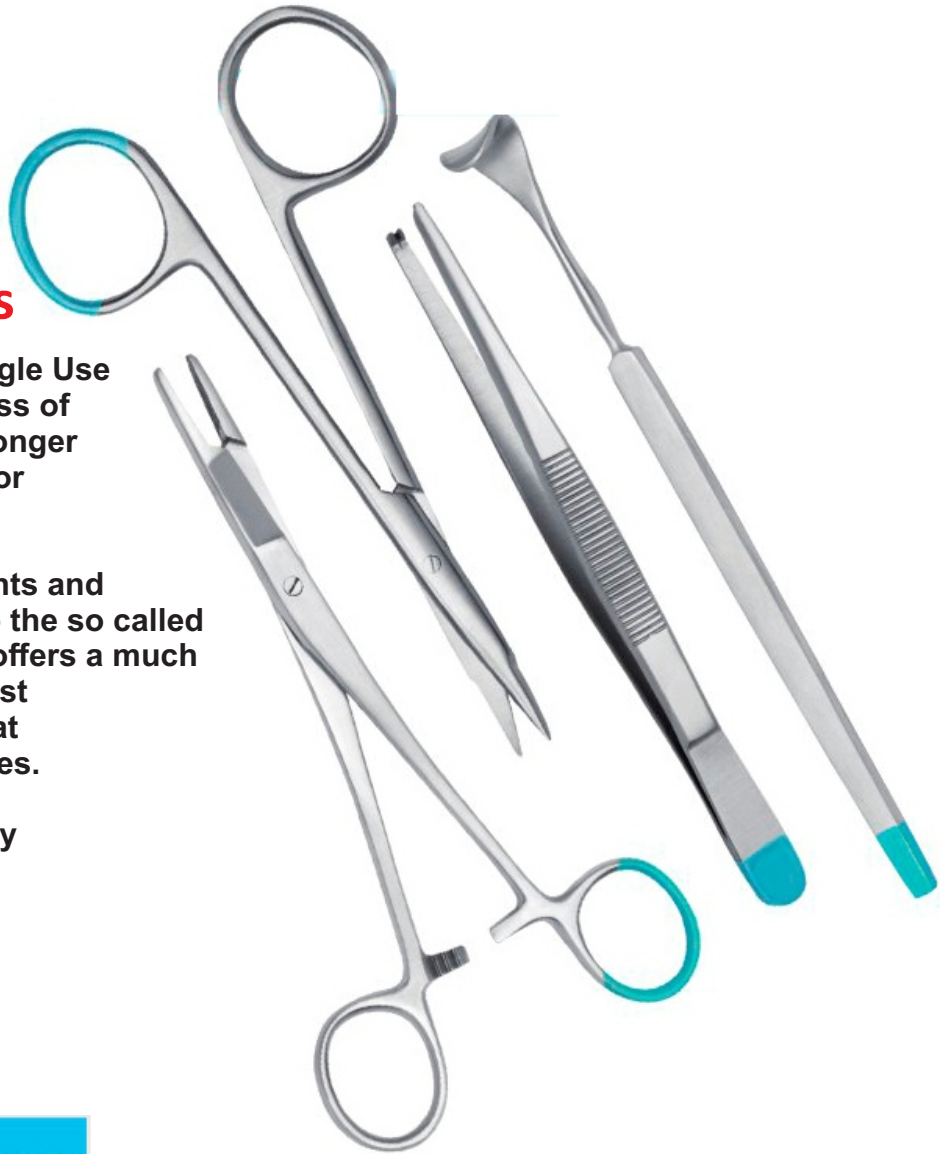



## Single Use Instruments

SUORG is the abbreviation for "Single Use Operating Room Grade", a high class of instruments that can last through longer procedures without loss of quality or functionality.

Common Single-us metal instruments and plastic metal instruments belong to the so called "Floor Room Grade" Sehar Batool offers a much higher quality in order to ensure best functionality and provide security, at comparable and least possible prices.

in all aspects a economic and highly competitive solution.



**Sehar Batool Single-use instruments completely fulfil the EN-ISO 15883 norm about cleaning and disinfection.**

**SEHAR BATOOL INTERNATIONAL**

**Tel:** +92 52 3552898    **Email:** amir.sehar@gmail.com    **Web:** www.seharbatool.com



## Single Use Instruments



**SEHAR BATOOL INTERNATIONAL**

Surgical scissors sh./sh., straight

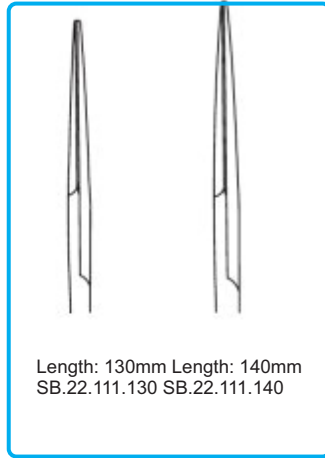

Surgical scissors sh./bl., straight

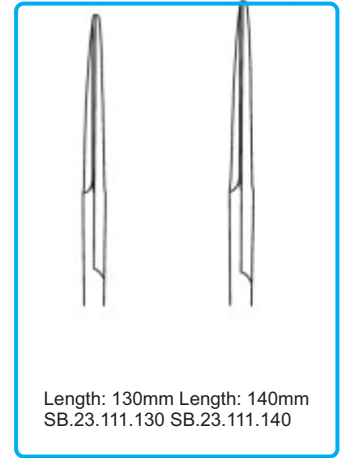

Surgical scissors bl./bl., straight

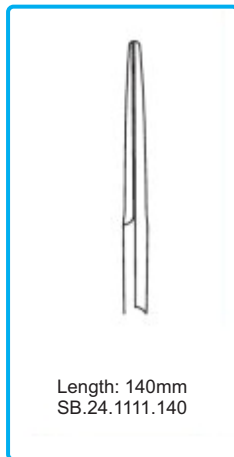

Surgical scissors sh./sh., curved

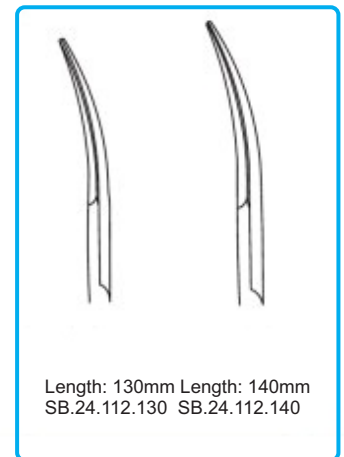

Surgical scissors sh./bl., curved

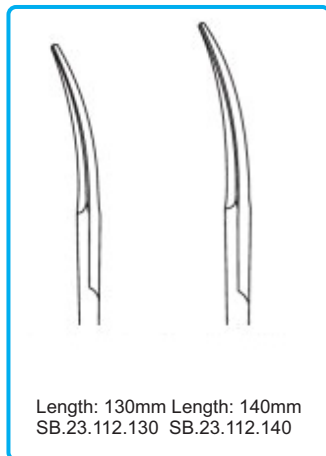

Surgical scissors bl./bl., curved

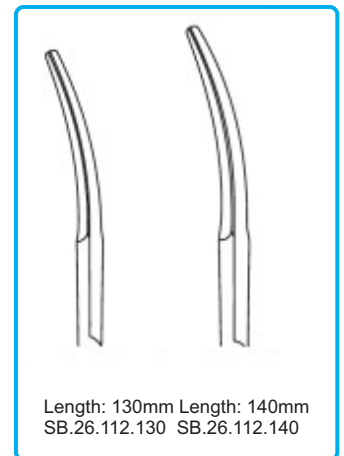



# Dissecting Scissors



Metzenbaum dissecting scissors, straight

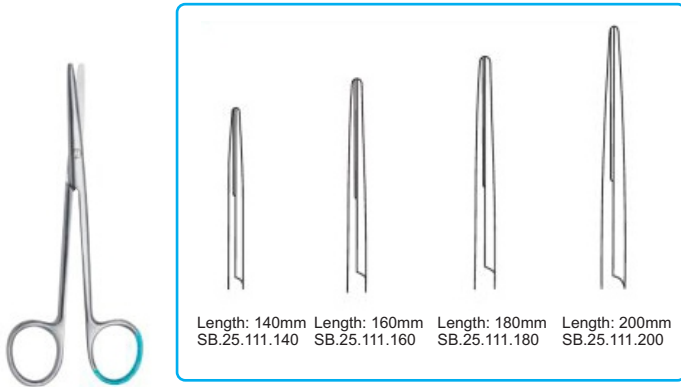

Metzenbaum dissecting scissors, curved

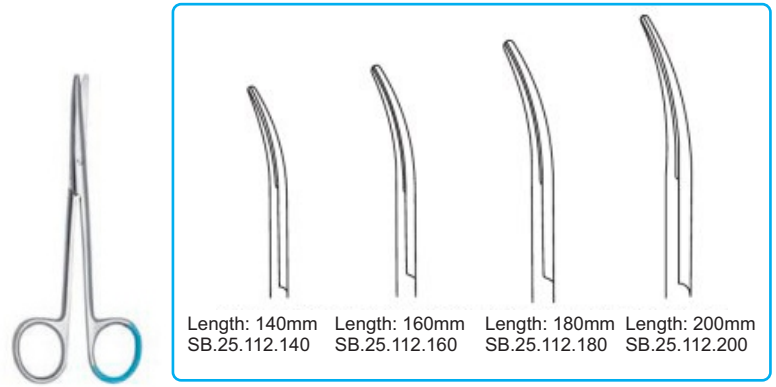

Stevens dissecting scissors, blunt, straight



Stevens dissecting scissors, blunt, curved

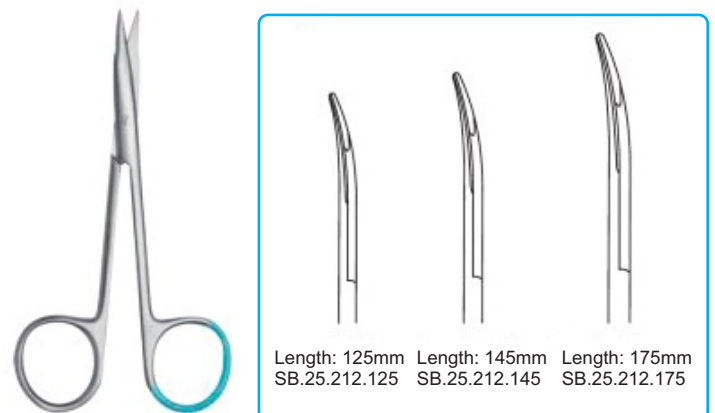

Mayo Dissecting Scissors, Straight



Mayo Dissecting Scissors, Curved



Universal Bandage Scissors  
Floor Room Grade



Lister bandage scissors

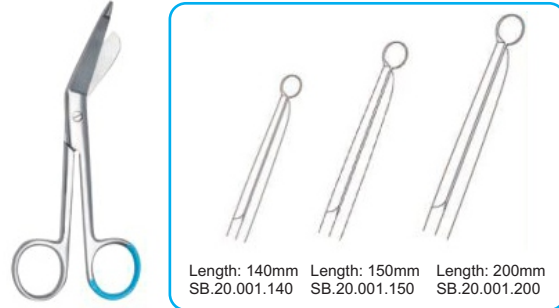

Iris Scissors, Straight

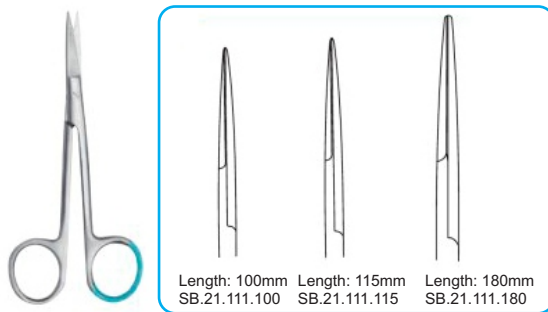

Iris Scissors, Curved

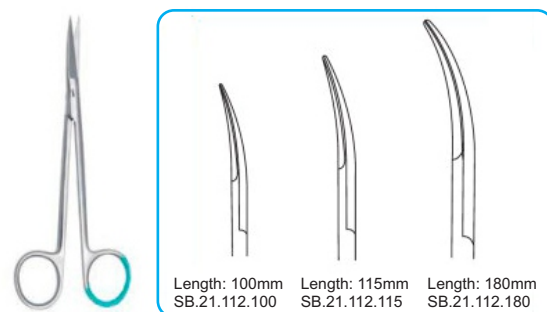

Spencer stitch / suture scissors, straight

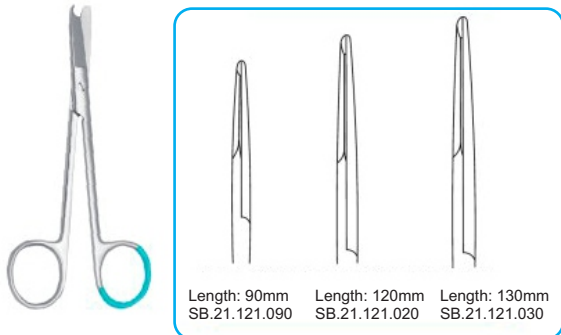

Noyes eye scissors

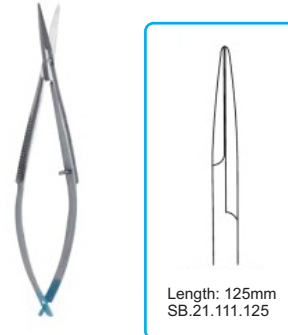

Braun-Stadler episiotomy scissor

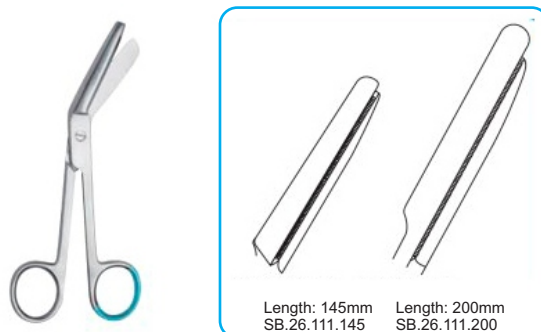

Episiotomy scissor





# Clamps

Maier sponge forceps, straight

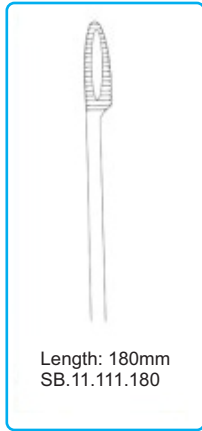

Tubing clamp forceps

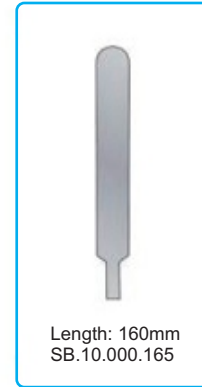

Sponge forceps, straight

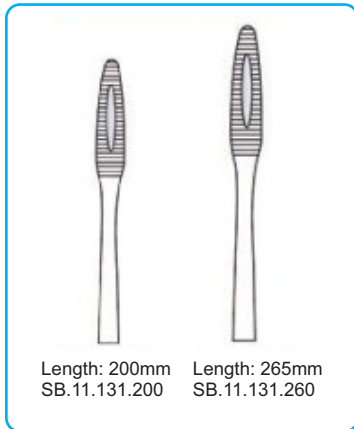

Sponge forceps, curved

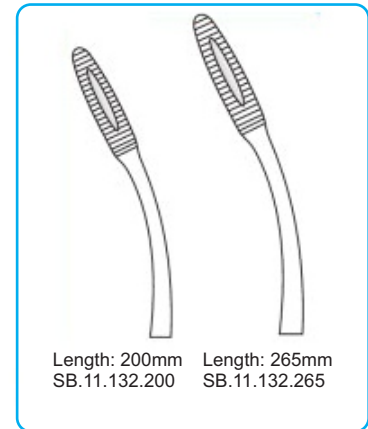

Forester sponge holding forceps, straight



Forester sponge holding forceps, curved

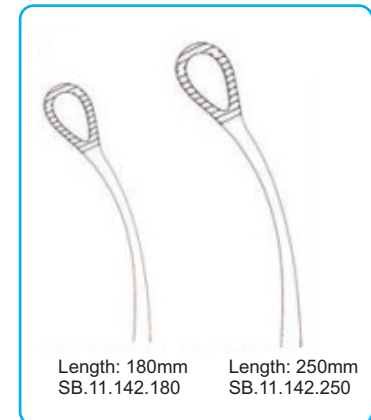



Halsted Mosquito Artery Forceps, Straight



Halsted Mosquito Artery Forceps, Curved



Birkett artery forceps, straight

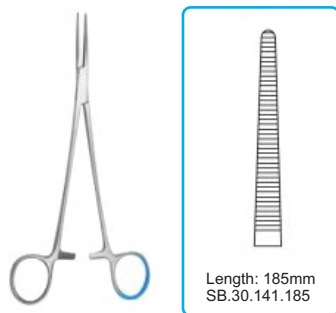

Birkett artery forceps, curved

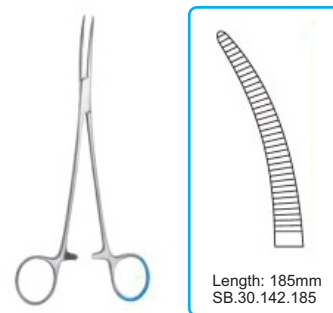

Rochester Pean Artery Forceps, straight

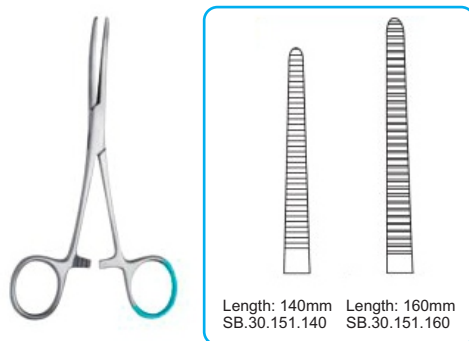

Rochester Pean Artery Forceps, curved

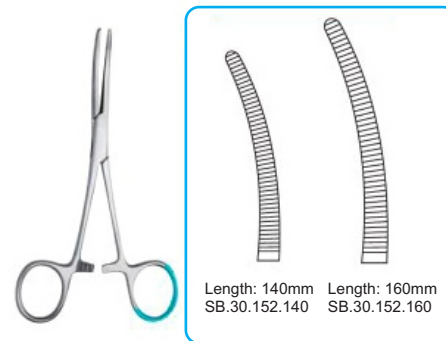

Pean artery forceps, straight







# Haemostatic Forceps (anatomic)



Micro Halsted artery forceps, straight

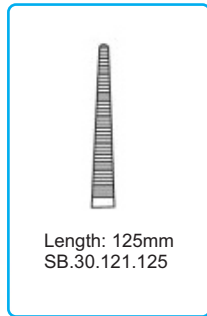

Length: 125mm  
SB.30.121.125

Micro Halsted artery forceps, curved

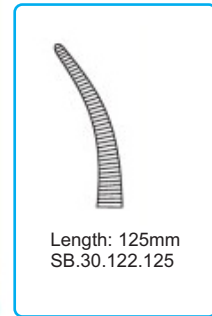

Length: 125mm  
SB.30.122.125

Kelly anatomic artery forceps, straight

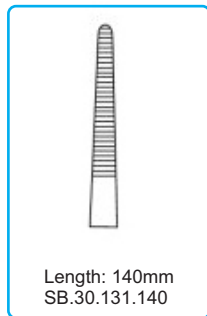

Length: 140mm  
SB.30.131.140

Kelly anatomic artery forceps, curved

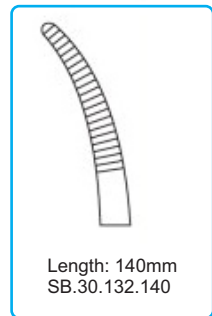

Length: 140mm  
SB.30.132.140

Crile artery forceps, straight

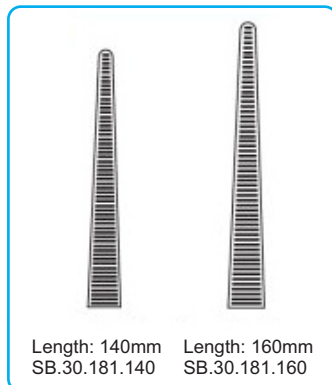

Length: 140mm Length: 160mm  
SB.30.181.140 SB.30.181.160

Crile artery forceps, curved

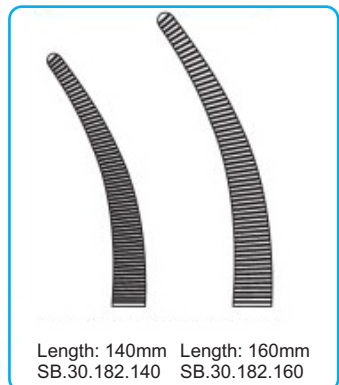

Length: 140mm Length: 160mm  
SB.30.182.140 SB.30.182.160



Micro halsted artery forceps, 1 x 2 teeth, straight



Micro halsted artery forceps, 1 x 2 teeth, curved

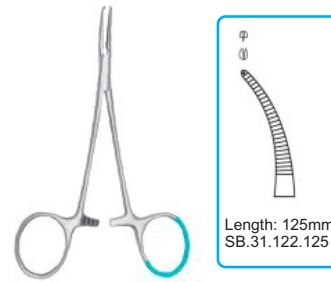

Kelly artery forceps, 1x2 teeth, straight

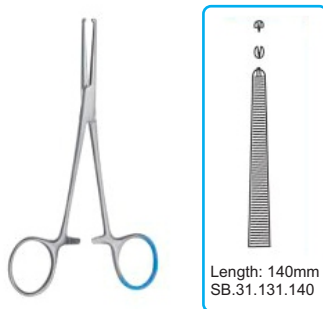

Kelly artery forceps, 1x2 teeth, curved

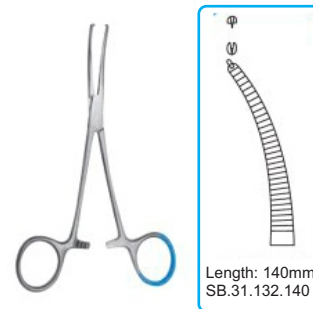

Kocher artery forceps, 1x2 teeth, straight

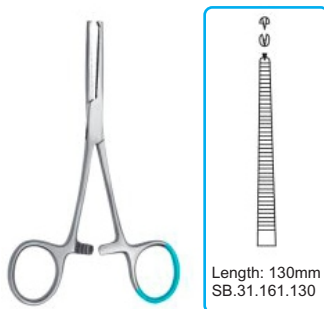

Kocher artery forceps, 1x2 teeth, curved

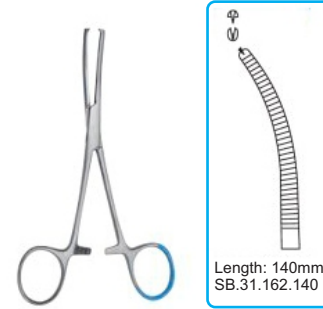

Halsted artery forceps, 1x2 teeth, straight

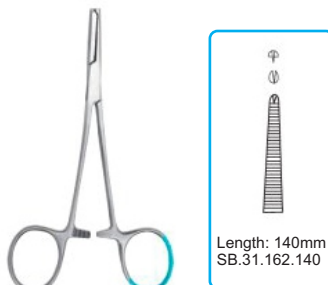

Halsted artery forceps, 1x2 teeth, curved





# Haemostatic Forceps (surgical)



Rochester-Ochsner Artery Forceps,  
1 x 2 teeth, Straight

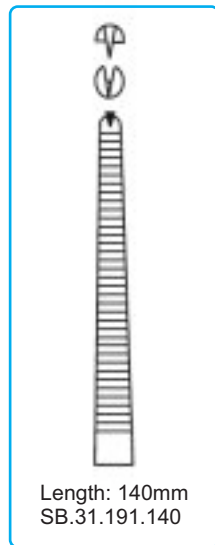

Rochester-Ochsner Artery Forceps,  
1 x 2 teeth, Curved

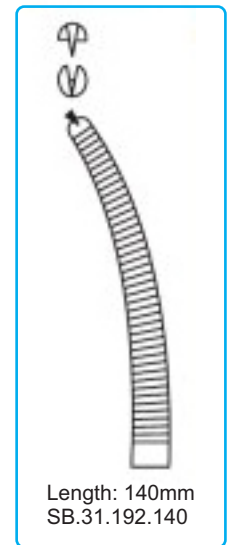

## Adson anatomic forceps

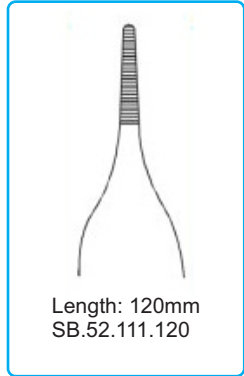

## Micro-Adson anatomic forceps, Fine

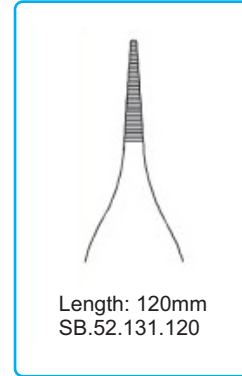

## Standard anatomic tissue forceps, fine



## Standard anatomic tissue forceps, fine



## Cushing anatomic forceps





# Surgical Forceps



## Adson tissue forceps, 1 x 2 teeth

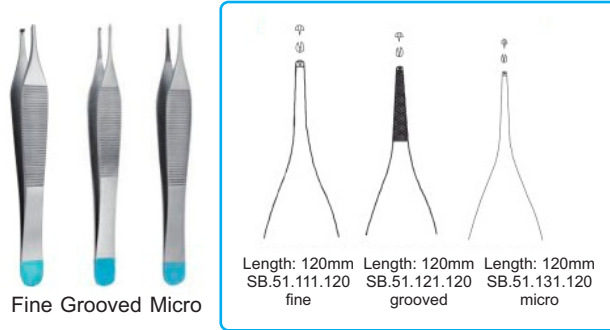

## Adson-Brown tissue forceps 7 x 7 teeth

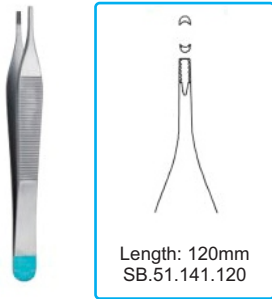

## Standard tissue forceps, 1 x 2 teeth

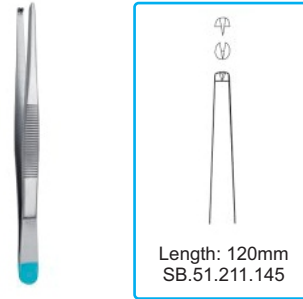

## Gillies tissue forceps, 1x2 teeth

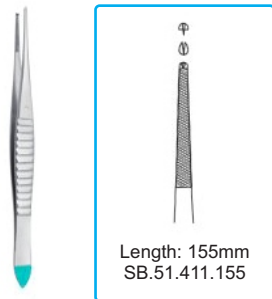

## Waugh tissue forceps, 1x2 teeth



## De Bakey Forceps

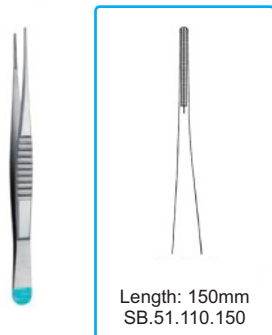

## Feilchenfeld splinter forceps

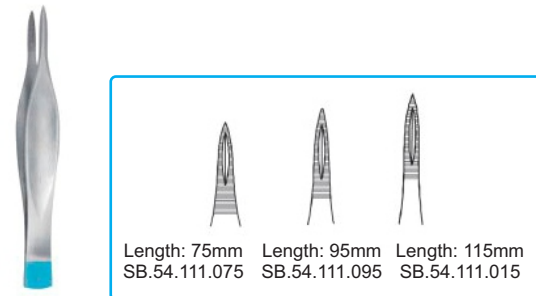

Mayo Hegar Needle Holder

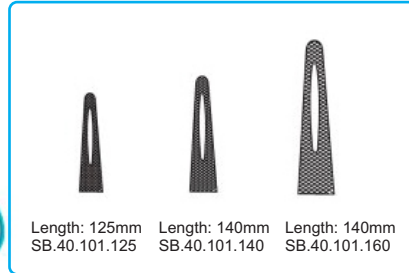

Mayo Hegar Needle Holder (spring scissors)

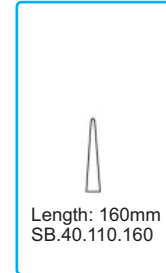

Olsen Hegar Needle Holder

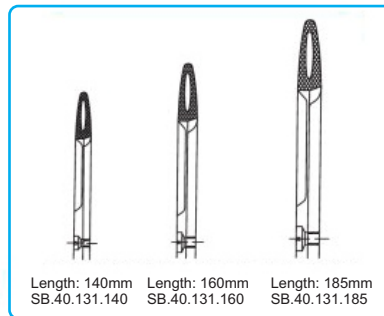

Crilewood Needle Holder



Derf needle holder

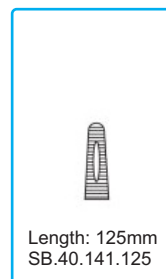



# Retractors and Spoons



**Senn-Miller retractors, double-ended, sharp**



Length: 155mm  
SB.16.100.155

**Roux Refractor**



Length: 170mm  
SB.61.200.170

**Gillies hook, skin retractor**



Length: 180mm  
SB.61.300.180

**Desmarres lid retractor with stable hook (9x12mm)**



Length: 140mm  
SB.62.100.140

**Weithlaner retractor, semi-sharp, 3x4 teeth**

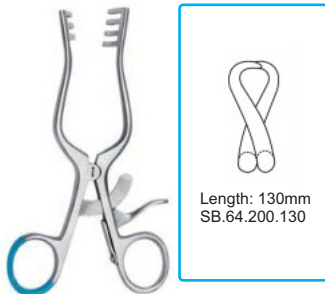

Length: 130mm  
SB.64.200.130

**Willinger spoon, oval**



Length: 170mm  
SB.63.100.170

**Bone curettes, double-ended, narrow, oval/round**

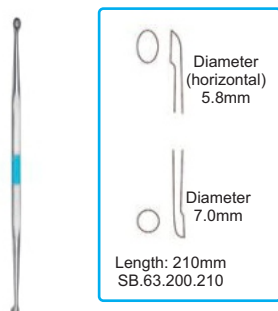

Diameter (horizontal)  
5.8mm

Diameter  
7.0mm

Length: 210mm  
SB.63.200.210

**Bone curettes, double-ended, wide, oval/round**

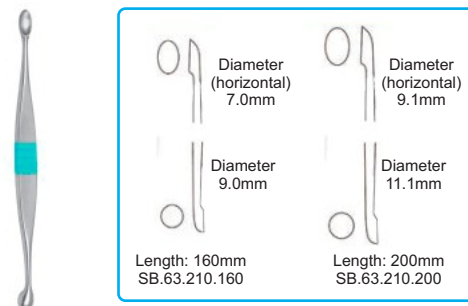

Diameter (horizontal)  
7.0mm

Diameter (horizontal)  
9.1mm

Diameter  
9.0mm

Diameter  
11.1mm

Length: 160mm  
SB.63.210.160

Length: 200mm  
SB.63.210.200

## Sterile Sets for Single-Use



### OR Set 1

Order Code: SB.99.400.001

1x	Metzenbaum dissecting scissors, curved, 140 mm
1x	Halsted mosquito artery forceps, curved, 125 mm
1x	Mayo-Hegar needle holder, 125 mm
1x	Adson anatomic forceps, straight, 120 mm
1x	Adson tissue forceps, 1 x 2 teeth, straight, 120mm

**Ask for our wide OR Set Program!**



### OR Set 2

Order Code: SB.99.400.002

1x	Mayo Dissecting Scissors, Curved, 140 mm
1x	Kocher artery forceps, straight, 1 x 2 teeth, 130 mm
1x	Mayo Hegar Needle Holder, 140 mm
1x	Standard anatomic tissue forceps, fine, 145 mm
1x	Standard tissue forceps, 1 x 2 teeth, 145mm





## Nursing Tools



**SB.01**



**SB.02**



**SB.03**



**SB.03**



**SB.04**



**SB.05**



**SB.07**



**SB.08**



**SB.09**



SB.10



SB.11



SB.12



SB.13



SB.14



SB.15



SB.16



SB.17



SB.18



SB.19



SB.20



SB.21

SB.22





Sehar Batool International was established with a mission to provide our valued clients with impeccable service in the field of advance and update, finest quality hand crafted Electro Surgical Instruments, Single-Use Surgical Instruments. Align with our team of professionals; we always strive for a Full satisfaction of a customer which is necessary for long terms business relations. We are also continuously developing new products, upgrading our instruments in all possible ways through technological enhancements and investigating under improved methods.

We are a company that sets high standards. Our growth has come from offering an unparalleled variety of innovative, high-quality products and services resulting from the dedication of our employees.

Full satisfaction of a customer is necessary for long terms business relations. We are committed to establish a life long partnership with all of our customers. Our commitment to quality, based on our continuous monitoring at every stage of the manufacturing process has placed us at par with international standards, while maintaining very competitive prices.

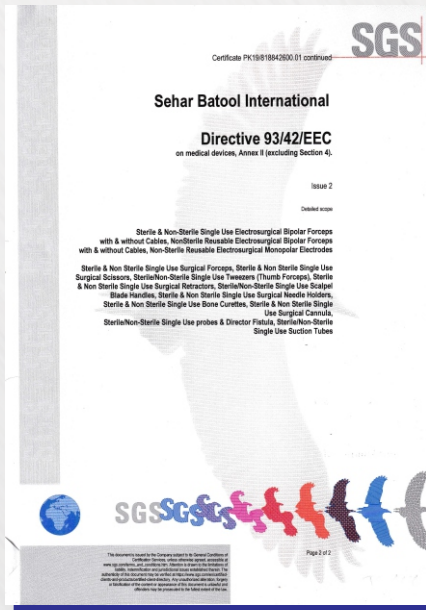
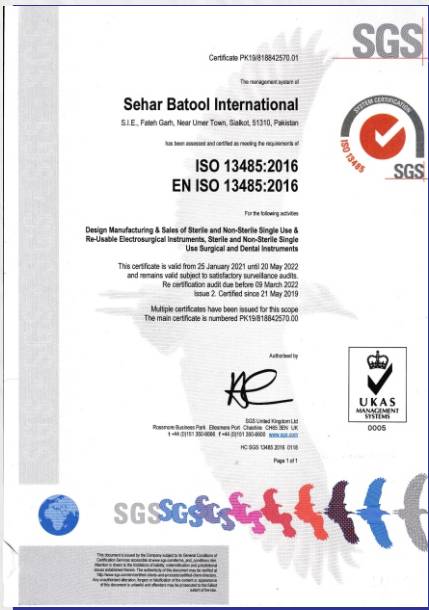



## **SEHAR BATOOL INTERNATIONAL**

**S.I.E Fateh Garh Near Umer Town Sialkot Pakistan**  
**Tel: +92 52-3552898 FAX: +92 52-3251597**

**Email: seharbatool@brain.net.pk / amir.sehar@gmail.com**  
**Website: www.seharbatool.com**

